

3 Port Solenoid Valve

Power consumption 0.1 W (with power saving circuit)



Series V100

Coil temperature rises: only 1°C (with power saving circuit)

Sonic conductance C: 0.037 (Standard)/C: 0.076 (Large flow capacity)

Series		Flow characteristics			
		C[dm ³ /(s·bar)]	b	Q[l/min]	Cv
Standard	V1□4	0.037	0.11	8.4	0.008
Large flow capacity	V1□4A	0.076	0.070	17	0.016

Variations

Series		Type of actuation	Operating pressure range (MPa)	Power consumption (W)	
				Standard	With power saving circuit
Standard	V114	N.C.	0 to 0.7	0.35	0.1
	V124	N.O.	0 to 0.7	0.35	0.1
Large flow capacity	V114A	N.C.	0 to 0.7	1	—
	V124A	N.O.	0 to 0.7	1	—

Rubber seal

3 Port Solenoid Valve/Direct Operated

Series V100

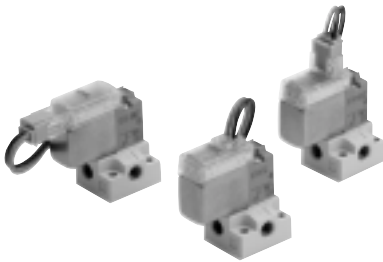

Specifications

Fluid	Air
Ambient and fluid temperature (°C)	-10 to 50 (No freezing. Refer to page 10.)
Response time (ms) ^{Note 1)}	ON: 5 or less OFF: 4 or less
Max. operating frequency (Hz)	20
Manual override	Non-locking push, Locking slotted
Lubrication	Not required
Mounting position	Unrestricted
Impact/Vibration resistance (m/s ²) ^{Note 2)}	150/30
Enclosure	Dust proof, equivalent IP40



Note 1) Based on dynamic performance test JIS B8374-1981 (standard type: at coil temperature of 20°C, with rated voltage, without surge voltage suppressor)

Note 2) Impact resistance: No malfunction resulted in an impact test using a drop impact tester. The test was performed one time each in the axial and right angle directions of the main valve and armature, for both energized and de-energized states. (Value in the initial stage)

Vibration resistance: No malfunction resulted in 45 to 2000 Hz, a one-sweep test performed in the axial and right angle directions of the main valve and armature for both energized and de-energized states. (Value in the initial stage)

Solenoid Specifications

Series		V114/V124	V114A/V124A
Electrical entry		Grommet (G)/(H), L plug connector(L) M plug connector (M)	
Coil rated voltage (V)	DC	24, 12, 6, 5, 3	
Allowable voltage fluctuation		-10 to 10%	
Power consumption (W)	DC	Standard: 0.35 (with light: 0.4) With power saving circuit 0.1	1 W (with light: 1.1)
Surge voltage suppressor		Refer to page 14.	
Indicator light		LED	

JIS symbol

V114(A)

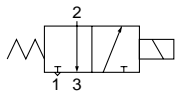

V124(A)

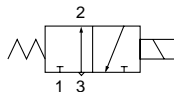

Specifications

Valve model	Type of actuation	Model	Operating pressure range (MPa)	Vacuum specification (MPa)		Port size		Weight (g) ^{Note 2)}	
				Port 1	Port 3	Ports 1,3	Port 2	Grommet	L plug connector M plug connector
V114	N.C.	Standard	0 to 0.7	-100 kPa to 0.6	-100 kPa to 0	M5	M5	V1□4:13(27) V1□4A:16(30)	Plug connector V1□4:12(26) V1□4A:15(29)
V114A	N.C.	Large flow capacity	0 to 0.7	-100 kPa to 0.6	-100 kPa to 0	M5	M5		
V124 ^{Note 1)}	N.O.	Standard	0 to 0.7	-100 kPa to 0	-100 kPa to 0.6	M5	M5		
V124A ^{Note 1)}	N.O.	Large flow capacity	0 to 0.7	-100 kPa to 0	-100 kPa to 0.6	M5	M5		

	Flow characteristics							
	1 → 2				2 → 3			
	C[dm ³ /(s·bar)]	b	Q[l/min]	Cv	C[dm ³ /(s·bar)]	b	Q[l/min]	Cv
V114	0.037	0.11	8.4	0.0080	0.054	0.35	14.2	0.015
V114A	0.076	0.070	17	0.016	0.099	0.23	24.1	0.024
V124 ^{Note 1)}	0.054	0.35	14.2	0.015	0.037	0.11	8.4	0.0080
V124A ^{Note 1)}	0.099	0.23	24.1	0.024	0.076	0.070	17	0.016

Note 1) For both V124, V124A, pressure from port 3 and exhaust from port 1.
 Note 2) The values shown in () are for values with sub-plate.

Construction

V114(A)

V124(A)

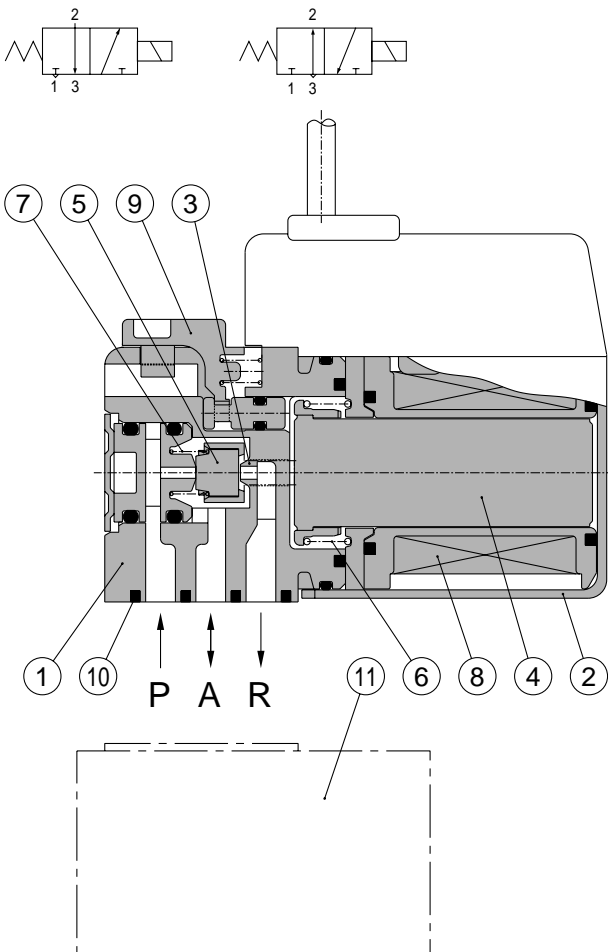

Component Parts

Number	Description	Material
1	Body	Resin
2	Cover	Stainless steel
3	Push rod	Resin
4	Armature assembly	Stainless steel, Resin
5	Poppet	FKM
6	Return spring	Stainless steel
7	Poppet spring	Stainless steel
8	Coil assembly	—
9	Manual override	Resin

Replacement Parts

Number	Description	No.	Material	Note
10	Gasket assembly	V100-31-1A	FKM, Steel	Gasket, 2 screws
11	Sub-plate	V100-74-1	Aluminum die-cast	—

How to Order Connector Assembly

For DC: **SY100-30-4A-**

Without lead wire: **SY100-30-A**
 (with connector and 2 sockets)

● **Lead wire length**

Nil	300 mm
6	600 mm
10	1000 mm
15	1500 mm
20	2000 mm
25	2500 mm
30	3000 mm
50	5000 mm

Standard

Base mounted V1 1 4 5 M

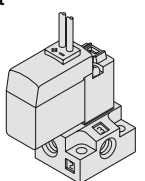
3 port

 For sub-plate style,
 For manifold type S41

Type of actuation

1	Normally closed
2	Normally open

Coil specification

Nil	0.35 W
T	0.1 W (with power saving circuit) (24 VDC, 12 VDC only)

* All the types with power saving circuit are with light/surge voltage suppressor.

Rated voltage

For DC

5	24 VDC
6	12 VDC
V	6 VDC
S	5 VDC
R	3 VDC

Electrical entry

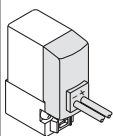
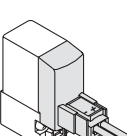
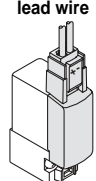
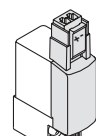
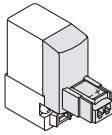
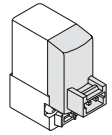
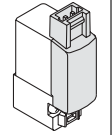
24 VDC, 12 VDC, 6 VDC, 5 VDC, 3 VDC			
Grommet	L plug connector	M plug connector	
G: 300 mm lead wire H: 600 mm lead wire	L: 300 mm lead wire	M: 300 mm lead wire	MN: Without lead wire
			
	LN: Without lead wire	LO: Without connector	MO: Without connector
			

Port size

Nil: Without sub-plate
 M5: With sub-plate
 (With gasket and screws)

Manual override

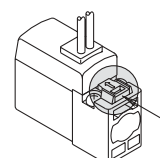
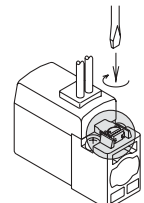
Nil: Non-locking push

 B: Locking slotted

Indicator light and surge voltage suppressor

Nil	Without indicator light or surge voltage suppressor
S	With surge voltage suppressor
Z	With indicator light and surge voltage suppressor
R	With surge voltage suppressor (Non-polar)
U	With indicator light and surge voltage suppressor (Non-polar)

* Only "Z" is available for the types with power saving circuit.

* LN and MN types are with 2 sockets.

How to Order

Large flow

Base mounted V1 **1** 4 **A** — **5** **M** [] [] []

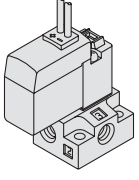
3 port

 For sub-plate style,
 For manifold type S41

Type of actuation

1	Normally closed
2	Normally open

High flow capacity

Rated voltage

For DC	
5	24 VDC
6	12 VDC
V	6 VDC
S	5 VDC
R	3 VDC

Port size

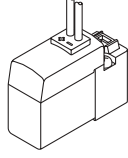
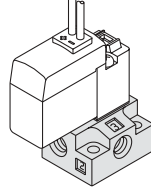
Nil: Without sub-plate	M5: With sub-plate
	
(With gasket and screws)	

Manual override

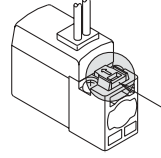
Nil: Non-locking push

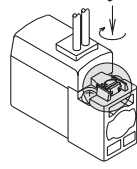
B: Locking slotted

Indicator light and surge voltage suppressor

Nil	Without indicator light or surge voltage suppressor	For DC, AC
R	With surge voltage suppressor	For DC
U	With indicator light and surge voltage suppressor	

Electrical entry

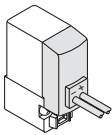
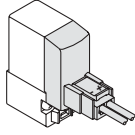
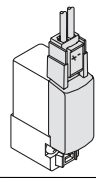
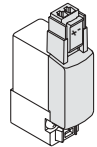
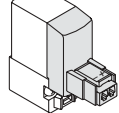
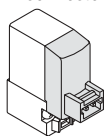
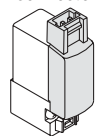
24 V, 12 V, 6 V, 5 V, 3 VDC			
Grommet	L plug connector	M plug connector	
G: 300 mm lead wire H: 600 mm lead wire	L: 300 mm lead wire	M: 300 mm lead wire	MN: Without lead wire
			
	LN: Without lead wire	LO: Without connector	MO: Without connector
			

* LN and MN types are with 2 sockets.

Series V100

Base Mounted (With sub-plate)

Note) []: values for large flow type (A).

Grommet (G), (H): V1 $\frac{1}{2}$ 4(A)-□^G□□-M5

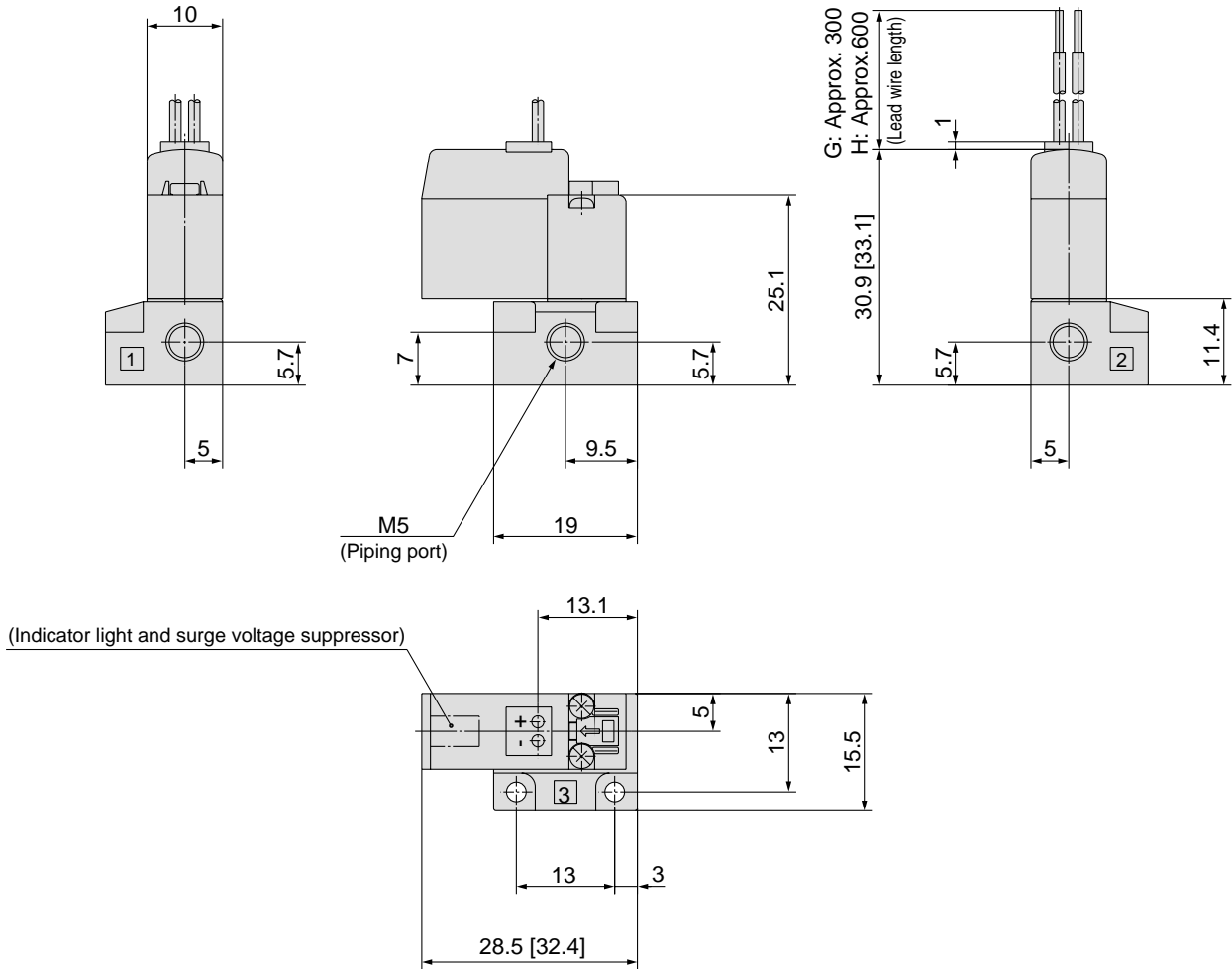

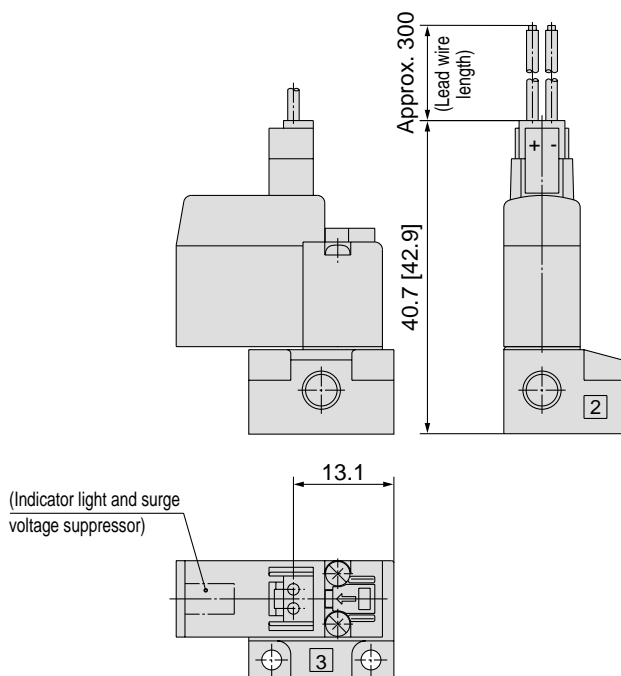

L plug connector (L): V1 $\frac{1}{2}$ 4(A)-□L□□-M5

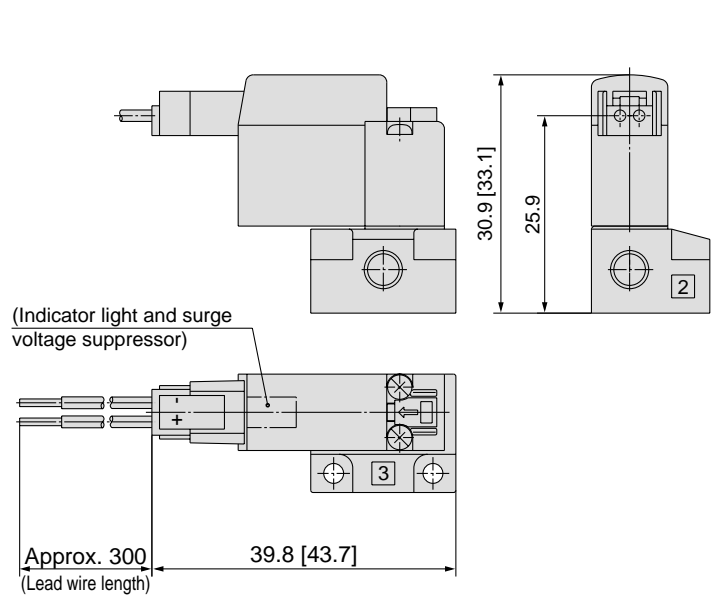

M plug connector (M): V1 $\frac{1}{2}$ 4(A)-□M□□-M5



5  * Other dimensions are same as grommet style.

 * Other dimensions are same as grommet style.

3 Port Solenoid Valve Series V100 Manifold Specifications

Manifold Specifications

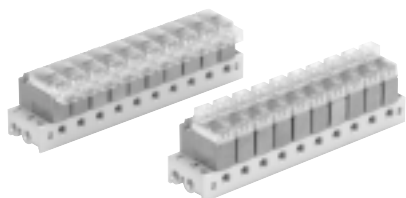

Specifications		Type S41
Manifold		Single base style/B mount
P (SUP)/R (EXH) style		Common SUP/Common EXH
Valve stations		2 to 20 stations
Output port porting specifications	Location	Base
	Direction	Side
Port size	1, 2, 3 port	M5

Note 1) V114(A) and V124(A) cannot be mounted onto the same manifold.
Note 2) For V124(A), pressure from port 3 and exhaust from port 1.

Flow Characteristics

Manifold		Port size 1, 2, 3 port	Flow characteristics							
			1 → 2				2 → 3			
			C[dm ³ /(s·bar)]	b	Q[l/min]	Cv	C[dm ³ /(s·bar)]	b	Q[l/min]	Cv
Type VV100-S41	V114	M5 x 0.8	0.032	0.13	7.4	0.0072	0.050	0.26	12.4	0.012
	V114A		0.070	0.10	15.9	0.016	0.085	0.16	19.9	0.020
	V124		0.050	0.26	12.4	0.012	0.032	0.13	7.4	0.0072
	V124A		0.085	0.16	19.9	0.020	0.070	0.10	15.9	0.016

Note) Values when manifold base (5 stations) is mounted.

How to Order Valve Manifold Assembly (Example)

Ordering example

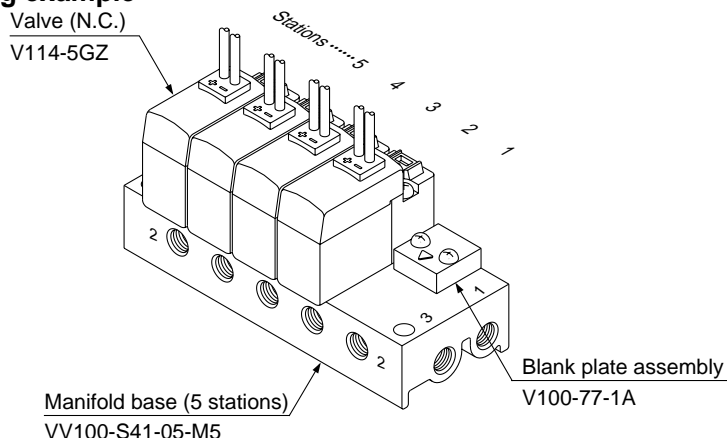

VV100-S41-05-M5 1 set (Type S41, 5 station manifold base part no.)

*V100-77-1A 1 set (Blank plate assembly number)

*V114-5GZ 4 sets (Valve)

↳ *To order valves and options mounted onto the manifold at the factory, list the valve/option with an asterisk (*) in front of each part number.

List part numbers of the installed valve and option in required station location separately under manifold part number.

Series V100

Common SUP/Common EXH

Type S41

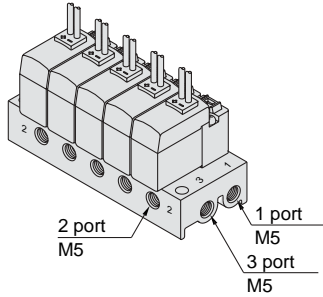

How to Order

VV100 - S41 - 05 - M5

Stations	
02	2 stations
⋮	⋮
20	20 stations

2 port size	
M5	M5

Applicable solenoid valve ^{Note)}

V114-□□□□
 V114A-□□□□
 V124-□□□□
 V124A-□□□□

Applicable blank plate assembly
 V100-77-1A



Note) V114(A) and V124(A) cannot be mounted to the same manifold.

Gasket assembly - Replacement part

Part-No. V100-31-1A

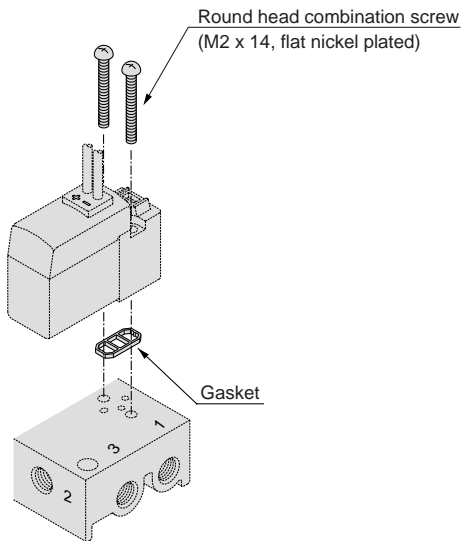

Applicable base

- Sub-plate
- Type VV100-S41 manifold base

Blank plate assembly - Accessory

Part-No. V100-77-1A

Place notch mark on the blank plate to 2 port side when assembling.

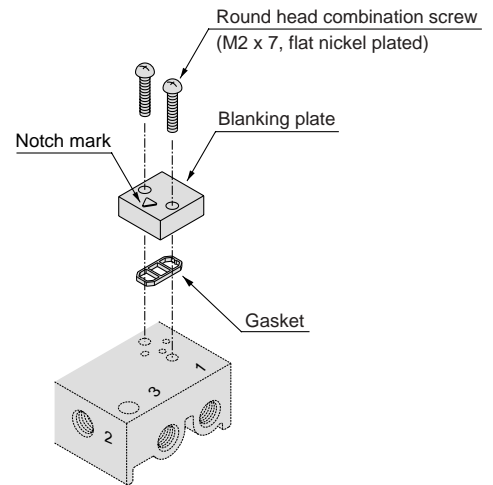

Applicable base

- Sub-plate
- Type VV100-S41 manifold base

⚠ Caution

Mounting screw tightening torques **M2: 0.12 N·m**

Manifold type S41: Side ported/VV100-S41-Stations-M5

Note) []: values for large flow type (A).

Grommet (G), (H)

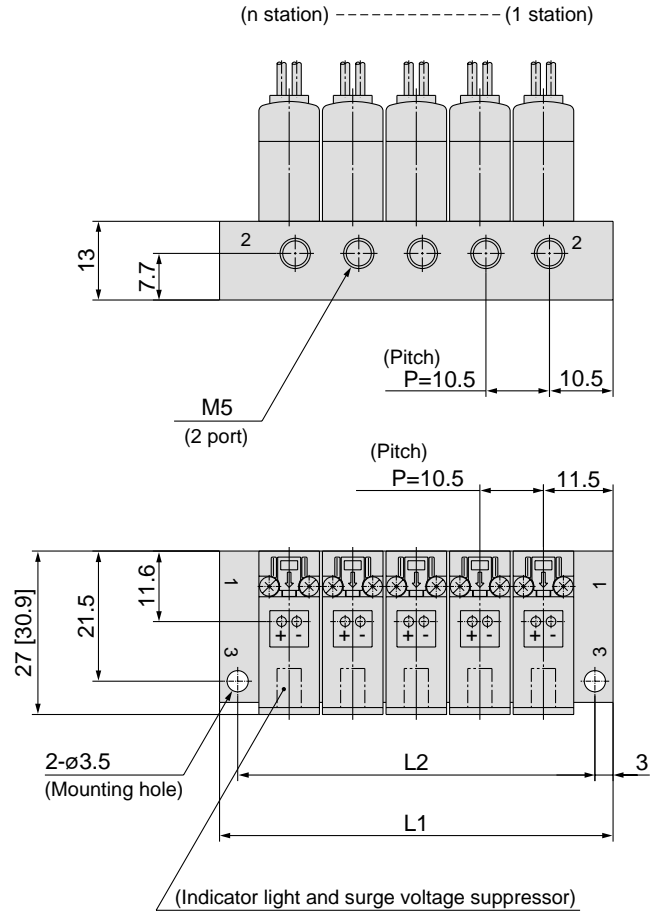
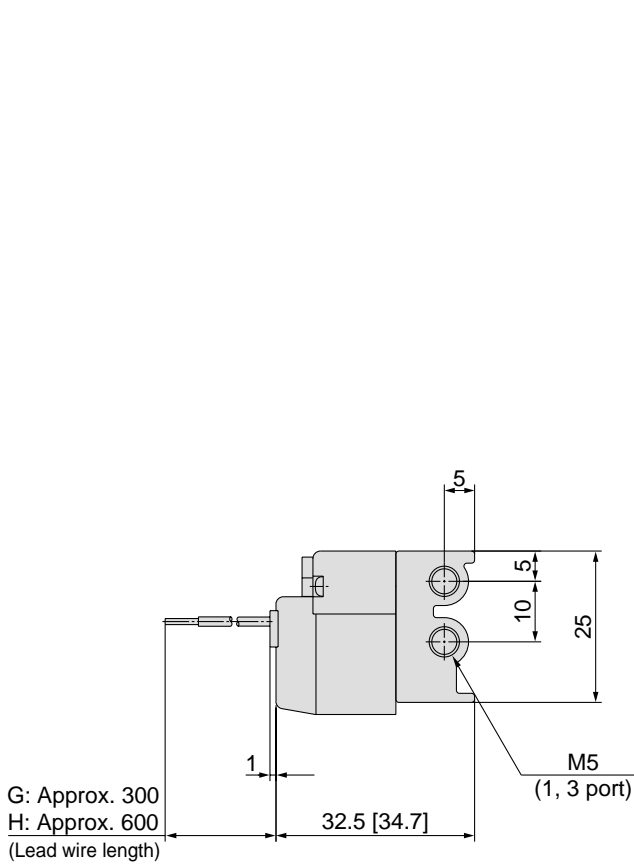

L plug connector (L)

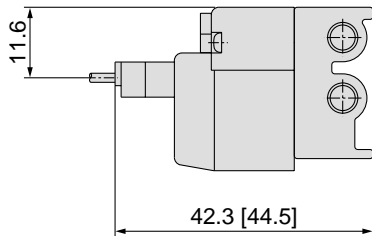

M plug connector (M)

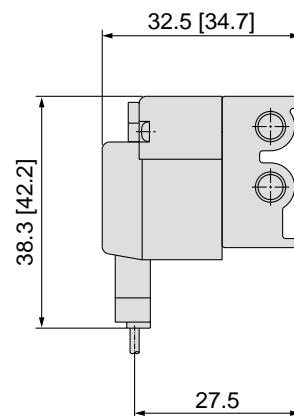

* Other dimensions are same as grommet style.
Formula for calculating the weight of the manifolds without valves:
Weight (g) = 7 + 9*n; (n = number of stations)

* Other dimensions are same as grommet style.

Station	2 stations	3	4	5	6	7	8	9	10	11	12	13	14	15	16	17	18	19	20 stations
L1	33.5	44	54.5	65	75.5	86	96.5	107	117.5	128	138.5	149	159.5	170	180.5	191	201.5	212	222.5
L2	27.5	38	48.5	59	69.5	80	90.5	101	111.5	122	132.5	143	153.5	164	174.5	185	195.5	206	216.5



Safety Instructions

These safety instructions are intended to prevent a hazardous situation and/or equipment damage. These instructions indicate the level of potential hazard by a label of "**Caution**", "**Warning**" or "**Danger**". To ensure safety, be sure to observe ISO 4414 ^{Note 1)}, JIS B 8370 ^{Note 2)} and other safety practices.

 **Caution** : Operator error could result in injury or equipment damage.

 **Warning** : Operator error could result in serious injury or loss of life.

 **Danger** : In extreme conditions, there is a possible result of serious injury or loss of life.

Note 1) ISO 4414: Pneumatic fluid power – General rules relating to systems

Note 2) JIS B 8370: Pneumatic system axiom

Warning

1. The compatibility of pneumatic equipment is the responsibility of the person who designs the pneumatic system or decides its specifications.

Since the products specified here are used in various operating conditions, their compatibility for the specific pneumatic system must be based on specifications or after analysis and/or tests to meet your specific requirements. The expected performance and safety assurance will be the responsibility of the person who has determined the compatibility of the system. This person should continuously review the suitability of all items specified, referring to the latest catalogue information with a view to giving due consideration to any possibility of equipment failure when configuring a system.

2. Only trained personnel should operate pneumatically operated machinery and equipment.

Compressed air can be dangerous if handled incorrectly. Assembly, handling or maintenance of pneumatic systems should be performed by trained and experienced operators.

3. Do not service machinery/equipment or attempt to remove components until safety is confirmed.

1. Inspection and maintenance of machinery/equipment should only be performed once measures to prevent falling or runaway of the driven object have been confirmed.
2. When equipment is to be removed, confirm the safety process as mentioned above. Cut the supply pressure for this equipment and exhaust all residual compressed air in the system.
3. Before machinery/equipment is restarted, take measures to prevent shooting-out of cylinder piston rod, etc.

4. Contact SMC if the product is to be used in any of the following conditions:

1. Conditions and environments beyond the given specifications, or if product is used outdoors.
2. Installation on equipment in conjunction with atomic energy, railway, air navigation, vehicles, medical equipment, food and beverages, recreation equipment, emergency stop circuits, clutch and brake circuits in press applications, or safety equipment.
3. An application which has the possibility of having negative effects on people, property, or animals, and therefore requires special safety analysis.



3 Port Solenoid Valve/Common Precautions 1

Be sure to read before handling.

Design

Warning

1. Actuator drive

When an actuator, such as a cylinder, is to be driven using a valve, take appropriate measures to prevent potential danger caused by actuator operation.

2. Effect of back pressure when using a manifold

Use caution when the valves are used on a manifold, as actuator malfunction due to back pressure may occur. Special caution is also necessary when driving a single acting cylinder. Take additional care in cases where there is a danger of malfunction due to this potential back-pressure.

3. Holding pressure (including vacuum)

Since valves are subject to air leakage, they cannot be used for applications such as holding pressure (including vacuum) in a pressure vessel.

4. The valve cannot be used as an emergency shutoff valve, etc.

The valves presented in this catalogue are not designed for safety applications such as an emergency shutoff valve. If the valves are used in this type of system, other reliable safety assurance measures should also be adopted.

5. Maintenance space

The installation should allow sufficient space for maintenance activities (removal of valve, etc.).

6. Release of residual pressure

Provide a residual pressure release function for maintenance purposes.

7. Vacuum applications

When a valve is used for vacuum switching, take appropriate measures against the suction of external dust or other contaminants through vacuum pads and exhaust ports.

8. Ventilation

When a valve is used inside a sealed control panel, etc., provide ventilation to prevent a pressure increase caused by exhausted air inside the control panel or temperature rise caused by the heat generated by the valve.

Selection

Warning

1. Confirm the specification.

The products presented in this catalogue are designed only for use in compressed air systems (including vacuum). Do not operate at pressures or temperatures, etc., beyond the range of specifications, as this can cause damage or malfunction. (Refer to specifications.)
Contact SMC when using a fluid other than compressed air (including vacuum).

2. Extended periods of continuous energization

- If a valve is continuously energized for long periods, heat generation of the coil may result in reduced performance and shorter service life. This may also have an adverse effect on the peripheral equipment in proximity. Should a valve be continuously energized for long periods, or its daily energized state exceeds its non energized state, please use an energy saving type valve with DC specifications. Under some operating conditions, alternative valves from those detailed above can be used (for example, valves with DC specifications). For more information, please consult SMC. It is also possible to avoid potential problems by shortening the energization time and using the valve as a N.O. (normally open) type.
- When solenoid valves are mounted in a control panel, employ measures to radiate excess heat, so that temperatures remain within the valve specification range. Use special caution when three or more stations sequentially aligned on the manifold are continuously energized since this will cause a drastic temperature rise.

Caution

1. Leakage voltage

When using a resistor in parallel with the switching element or using a C-R element (surge voltage suppressor) for protection of the switching element, note that leakage voltage will increase due to leakage current flowing through the resistor or C-R element. Limit the amount of residual leakage voltage to the following value:

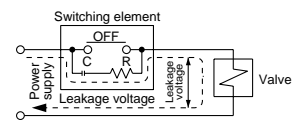

DC coil : 3% or less of the rated voltage

2. Surge voltage suppressor

If a surge protection circuit contains non-ordinary diodes such as Zener diodes or ZNRs, a residual voltage that is in proportion to the protective elements and the rated voltage will remain. Therefore, give consideration to surge voltage protection of the controller. In the case of diodes, the residual voltage is approximately 1 V.

3. Low temperature operation

Take appropriate measures to avoid freezing of drainage, moisture, etc. Valve use is still possible to temperature extremes of -10°C , unless there are specific instructions on the valve.

4. Mounting orientation

The mounting orientation is unrestricted.



3 Port Solenoid Valve/Common Precautions 2

Be sure to read before handling.

Mounting

⚠ Warning

1. If air leakage increases or equipment does not operate properly, stop operation.

Check mounting conditions when air and power supplies are connected. Initial function and leakage tests should be performed after installation.

2. Instruction manual

Mount and operate the product after reading the manual carefully and understanding its contents.

Also keep the manual where it can be referred to as necessary.

3. Painting and coating

Warnings or specifications printed or pasted on the product should not be erased, removed or covered up.

Consult SMC if paint is to be applied to resinous parts, as this may have an adverse effect due to the paint solvent.

Piping

⚠ Caution

1. Preparation before piping

Before piping is connected, it should be thoroughly blown out with air (flushing) or washed to remove chips, cutting oil and other debris from inside the pipe.

2. Wrapping of sealant tape

When connecting pipes and fittings, etc., be sure chips from the pipe threads and sealing material do not get inside the valve. Furthermore, when sealant tape is used, leave 1.5 to 2 thread ridges exposed at the end of the threads.

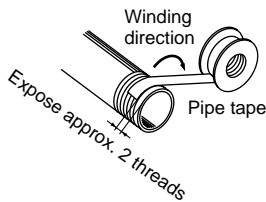

3. Screwing in fitting

When screwing fittings into valves, tighten as follows.

1) M5

(1) When installing SMC fittings, etc., follow the procedures below.

After tightening by hand, tighten an additional 1/6 rotation for M5 with a tool. However, when using a miniature fitting, tighten an additional 1/4 rotation with a tool after tightening by hand. Also, when there are 2 gaskets such as in case of a universal elbow or universal tee, tighten an additional 1/2 rotation.

Note) If overtightened, threaded part may be broken or gasket deformed. If tightened insufficiently, thread part may be loosened. In either case, air leakage could occur.

(2) When using a fitting brand other than SMC, follow the instruction by the manufacturer of the fittings.

Piping

4. Connection of piping to products

When connecting piping to a product, refer to its instruction manual to avoid mistakes regarding the supply port, etc.

Wiring

⚠ Caution

1. Polarity

When connecting power to a DC specification solenoid valve with (light/) surge voltage suppressor, confirm whether or not there is polarity. If a mistake is made regarding polarity, it will not be possible to switch the valve.

2. Applied voltage

When electric power is connected to a solenoid valve, be careful to apply the proper voltage. Improper voltage may cause malfunction or coil damage.

3. Confirm the connections.

After completing the wiring, confirm that the connections are correct.

Lubrication

⚠ Caution

1. Lubrication

1) The valve has been lubricated for life at the manufacturer, and does not require any further lubrication.

2) If a lubrication is applied in the system, use turbine oil Class 1 (no additive), ISO VG32.

However, once lubrication is applied it must be continued, as loss of the original lubricant may lead to malfunction.



3 Port Solenoid Valve/Common Precautions 3

Be sure to read before handling.

Air Supply

Warning

1. Use clean air.

Do not use compressed air which contains chemicals, synthetic oils containing organic solvents, salts or corrosive gases, etc., as this can cause damage or malfunction.

Caution

1. Install air filters.

Install air filters close to valves at their upstream side. A filtration degree of 5 μm or less should be selected.

2. Install an air dryer, after cooler or Drain Catch, etc.

Air that includes excessive drainage may cause malfunction of valves and other pneumatic equipment. To prevent this, install an air dryer, after-cooler or water separator, etc.

3. If excessive carbon powder is seen, install a mist separator on the upstream side of the valve.

If excessive carbon dust is generated by the compressor, it may adhere to the inside of valves and cause malfunction.

Refer to "SMC Best Pneumatic" catalogue vol. 4 for compressed air quality.

Operating Environment

Warning

1. Do not use in atmospheres where the valve is in direct contact with corrosive gases, chemicals, salt water, water or steam.

2. Do not use in an explosive atmosphere.

3. Do not use in locations subject to vibration or impact. Confirm the specifications in the main section of the catalogue.

4. Use a protective cover, etc., to shield valves from direct sunlight.

5. Shield valves from radiated heat generated by nearby heat sources.

6. Employ suitable protective measures in locations where there is contact with oil or welding spatter, etc.

7. When solenoid valves are mounted in a control panel or are energized for extended periods of time, employ measures to radiate excess heat, so that temperatures remain within the valve specification range.

Maintenance

Warning

1. Perform maintenance procedures as shown in the instruction manual.

If handled improperly, malfunction or damage of machinery or equipment may occur.

2. Removal of equipment and supply/exhaust of compressed air

When equipment is serviced, first confirm that measures are in place to prevent dropping of work pieces and run-away of equipment, etc. Then cut the supply pressure and power, and exhaust all compressed air from the system using its residual pressure release function.

When the equipment is to be started again after remounting or replacement, first confirm that measures are in place to prevent lurching of actuators, etc., and then confirm that the equipment is operating normally.

3. Low frequency operation

Valves should be switched at least once every 30 days to prevent malfunction. (Use caution regarding the air supply.)

4. Manual override operation

When the manual override is operated, connection equipment will be actuated. Start the operation after confirming its safety.

Caution

1. Drain flushing

Remove drainage from air filters regularly.

2. Lubrication

Lubricate turbine oil Class 1 (no additives), VG32. If other lubricant oil is used, it may cause malfunction. Contact us for suggested turbine oil Class 2(with additive), VG32.



Series V100/Specific Product Precautions 1

Be sure to read before handling.

Refer to pages 9 through 12 for safety instructions, precautions.

Warning Manual Override Operation

Since connected equipment will be actuated when the manual override is operated, first confirm that conditions are safe.

■ **Non-locking push style**
[Standard style]
Press in the direction of the arrow

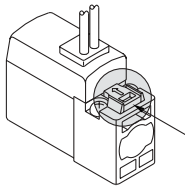

■ **Locking slotted style [B]**
Turn in the direction of arrow.

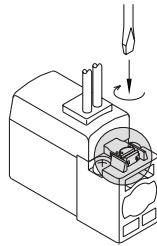

Caution

When operating with a screw driver, turn it gently using a watchmakers screw driver. [Torque: less than 0.1Nm]

Caution

How to Use Plug Connector

1. Attaching and detaching connectors

- To attach a connector, hold the lever and connector unit between your fingers and insert straight onto the pins of the solenoid valve so that the lever's pawl is pushed into the groove and locks.
- To detach a connector, remove the pawl from the groove by pushing the lever downward with your thumb, and pull the connector straight out.

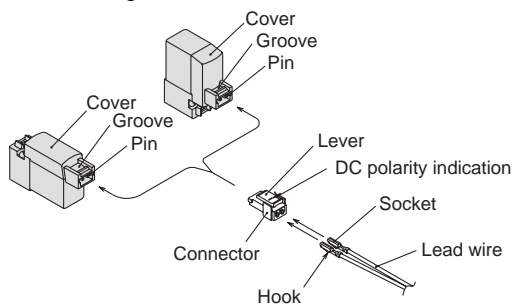

2. Crimping of lead wires and sockets

Strip 3.2 to 3.7 mm at the end of the lead wires, insert the ends of the core wires evenly into the sockets, and then crimp with a crimping tool. When this is done, take care that the coverings of the lead wires do not enter the core wire crimping area.

Use a special tool when crimping. (Consult SMC for the crimping tool.)

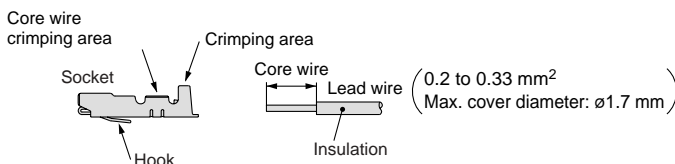

3. Attaching and detaching lead wires with sockets

●Attaching

Insert the sockets into the square holes of the connector (+, - indication), and continue to push the sockets all the way in until they lock by hooking into the seats in the connector. (When they are pushed in, their hooks open and they are locked automatically.) Then confirm that they are locked by pulling lightly on the lead wires.

●Detaching

To detach a socket from a connector, pull out the lead wire while pressing the socket's hook with a stick having a thin tip (about 1 mm). If the socket will be used again, first spread the hook outward.

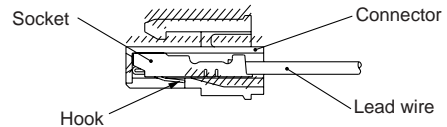

Plug Connector Lead Wire Length

Standard length is 300 mm, but the following length is also available.

How to Order Connector Assembly

For DC: **SY100-30-4A**

Without lead wire: **SY100-30-A**
(with connector and 2 pcs. of socket)

How to order

To order a valve with lead wire length of other than 300 mm, indicate part numbers of the valve without connector and the required connector assembly separately.

<Example> Lead wire length 2000 mm

For DC
V114-5LO
SY100-30-4A-20

●Lead wire length

Nil	300 mm
6	600 mm
10	1000 mm
15	1500 mm
20	2000 mm
25	2500 mm
30	3000 mm
50	5000 mm



Series V100/Specific Product Precautions 2

Be sure to read before handling.

Refer to pages 9 through 12 for safety instructions, precautions.

Surge Voltage Suppressor

<For DC>

Grommet, L and M plug connector

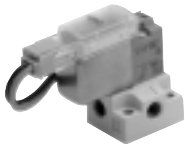

Standard style (With polarity) With surge voltage suppressor (□S)

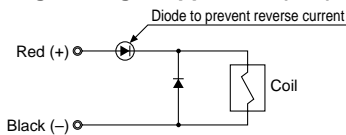

Indicator light and surge voltage suppressor (□Z)

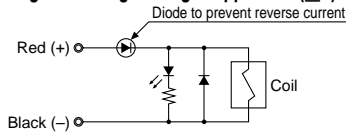

Non-polar style With surge voltage suppressor (□R)

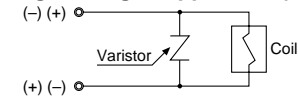

Indicator light and surge voltage suppressor (□U)

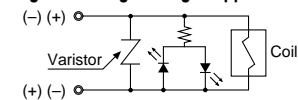

- Please connect correctly the lead wires to + (positive) and - (negative) indications on the connector.
- For DC voltages other than 12, 24 VDC, incorrect wiring will cause damage to the surge voltage suppressor circuit since a diode to prevent reverse current is not provided. (Wrong polarity will cause trouble.)
- Solenoids, whose lead wires have been pre-wired: positive side red and negative side black.

With power saving circuit

Power consumption is reduced by approximately 75% compared with the standard product by eliminating the need for electrical current for holding. (Effective after more than 62 ms energized and 24 VDC rated voltage applied.)

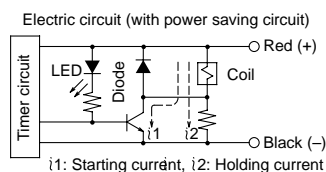

Operating principle

The electrical circuit as shown above, allows reduced holding current consumption and measures power saving. Refer to the electric waveform on the right.

<Electric waveform in power saving, in the case of V1,4T>

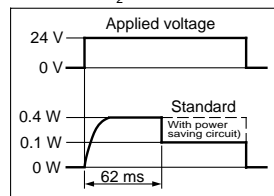

Connector Assembly with Cover

Connector assembly with protective cover enhances dust protection

- Effective in preventing possible short circuit problems due to contaminants in contact with connector section.
- Cover material is chloroprene rubber which has excellent weatherability and electric insulation properties. However, be careful not to allow contact with cutting oil, etc.
- Round cord provides neat appearance.

How to Order

SY100-68-A-□

Lead wire length (L)

Nil	300 mm
6	600 mm
10	1000 mm
15	1500 mm
20	2000 mm
25	2500 mm
30	3000 mm
50	5000 mm

Connector Assembly with Cover/Dimensions

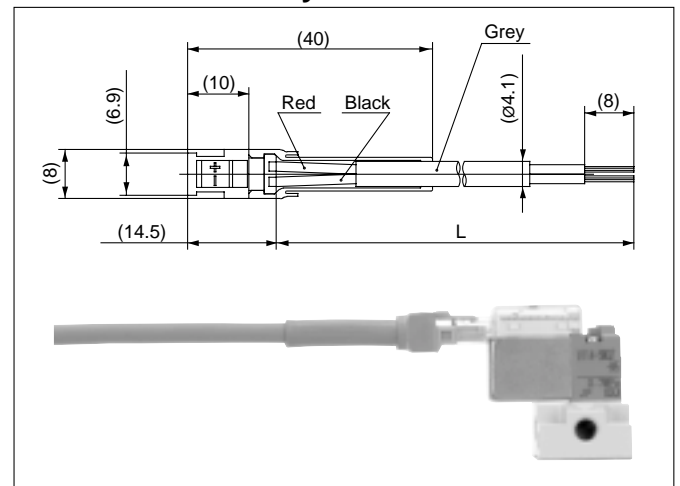

How to Order

Indicate part number of connector assembly with cover in addition to the solenoid valve part number without connector of the plug connector.

<Example 1> Lead wire length: 2000 mm

V114-5LOZ-M5

SY100-68-A-20

<Example 2> Lead wire length: 300 mm (Standard)

V114-5LPZ-M5

Symbol of connector assembly with protective cover

* No part numbers of connector assembly with cover are needed to be indicated in this case.



EUROPEAN SUBSIDIARIES:



Austria

SMC Pneumatik GmbH (Austria).
Girakstrasse 8, A-2100 Korneuburg
Phone: +43 2262-62280, Fax: +43 2262-62285
E-mail: office@smc.at
http://www.smc.at



Germany

SMC Pneumatik GmbH
Boschring 13-15, D-63329 Egelsbach
Phone: 06103-4020, Fax: 06103-402139
E-mail: info@smc-pneumatik.de
http://www.smc-pneumatik.de



Netherlands

SMC Pneumatics BV
De Ruyterkade 120, NL-1011 AB Amsterdam
Phone: 020-5318888, Fax: 020-5318880
E-mail: info@smcpneumatics.nl



Slovenia

SMC industrijska Avtomatika d.o.o.
Grajski trg 15, SLO-8360 Zuzemberk
Phone: +386 738 85240 Fax: +386 738 85249
E-mail: office@smc-ind-avtom.si
http://www.smc-ind-avtom.si



Belgium

SMC Pneumatics N.V./S.A.
Nijverheidsstraat 20, B-2160 Wommelgem
Phone: 03-355-1464, Fax: 03-355-1466
E-mail: post@smcpneumatics.be



Greece

S. Parianopoulos S.A.
7, Konstantinoupoleos Street,
GR-11855 Athens
Phone: 01-3426076, Fax: 01-3455578



Norway

SMC Pneumatics Norway A/S
Vollsveien 13 C, Granfos Næringspark
N-1366 Lysaker
Tel: (47) 67 12 90 20, Fax: (47) 67 12 90 21
http://www.smc-norge.no



Spain

SMC España, S.A.
Zuazobidea 14
01015 Vitoria
Phone: 945-184 100, Fax: 945-184 124
E-mail: post@smc.smces.es



Czech Republic

SMC Industrial Automation CZ s.r.o.
Hudcova 78a, CZ-61200 Brno
Phone: +420 5 414 24611, Fax: +420 5 412 18034
E-mail: office@smc.cz
http://www.smc.cz



Hungary

SMC Hungary Ipari Automatizálási Kft.
Budafoki ut 107-113, H-1117 Budapest
Phone: +36 1 371 1343, Fax: +36 1 371 1344
E-mail: office@smc-automation.hu
http://www.smc-automation.hu



Poland

SMC Industrial Automation Polska Sp.z.o.o.
ul. Konstruktorska 11A, PL-02-673 Warszawa,
Phone: +48 22 548 5085, Fax: +48 22 548 5087
E-mail: office@smc.pl
http://www.smc.pl



Sweden

SMC Pneumatics Sweden AB
Ekhagsvägen 29-31, S-141 71 Huddinge
Phone: 08-603 07 00, Fax: 08-603 07 10
http://www.smc.nu



Denmark

SMC Pneumatik A/S
Knudsminde 4B, DK-8300 Odder
Phone: (45)70252900, Fax: (45)70252901
E-mail: smc@smc-pneumatik.dk



Ireland

SMC Pneumatics (Ireland) Ltd.
2002 Citywest Business Campus,
Naas Road, Saggart, Co. Dublin
Phone: 01-403 9000, Fax: 01-464-0500



Portugal

SMC Sucursal Portugal, S.A.
Rua de Engº Ferreira Dias 452, 4100-246 Porto
Phone: 22-610-89-22, Fax: 22-610-89-36
E-mail: postpt@smc.smces.es



Switzerland

SMC Pneumatik AG
Dorfstrasse 7, CH-8484 Weisslingen
Phone: 052-396-3131, Fax: 052-396-3191
E-mail: info@smc.ch
http://www.smc.ch



Estonia

SMC Pneumatics Estonia OÜ
Laki 12-101, 106 21 Tallinn
Phone: 06 593540, Fax: 06 593541
http://www.smc-pneumatics.ee



Italy

SMC Italia S.p.A
Via Garibaldi 62, I-20061 Carugate, (Milano)
Phone: 02-92711, Fax: 02-9271365
E-mail: mailbox@smcitalia.it
http://www.smcitalia.it



Romania

SMC Romania srl
Str. Frunzei 29, Sector 2, Bucharest
Phone: 01-324-2626, Fax: 01-324-2627
E-mail: smccadm@canad.ro
http://www.smcromania.ro



Turkey

Entek Pnömatik San. ve Tic. Ltd. Sti.
Perpa Tic. Merkezi Kat: 11 No: 1625,
TR-80270 Okmeydanı Istanbul
Phone: 0212-221-1512, Fax: 0212-221-1519
http://www.entek.com.tr



Finland

SMC Pneumatics Finland OY
PL72, Tiistinniityntie 4, SF-02031 ESPOO
Phone: 09-859 580, Fax: 09-8595 8595
http://www.smc-fitec.sci.fi



Latvia

SMC Pneumatics Latvia SIA
Smerla 1-705, Riga LV-1006, Latvia
Phone: 0777-94-74, Fax: 0777-94-75
http://www.smclv.lv



Russia

SMC Pneumatik LLC.
36/40 Sredny pr. St. Petersburg 199004
Phone: (812) 118 5445, Fax: (812) 118 5449
E-mail: smcfa@peterlink.ru
http://www.smc-pneumatik.ru



UK

SMC Pneumatics (UK) Ltd
Vincent Avenue, Crownhill,
Milton Keynes, MK8 0AN
Phone: 0800 1382930 Fax: 01908-555064
E-mail: sales@smcpneumatics.co.uk
http://www.smc-pneumatics.co.uk



France

SMC Pneumatique, S.A.
1, Boulevard de Strasbourg, Parc Gustave Eiffel
Bussy Saint Georges
F-77607 Marne La Vallée Cedex 3
Phone: 01-6476 1000, Fax: 01-6476 1010
http://www.smc-france.fr



Lithuania

UAB Ottensten Lietuva
Savanoriu pr. 180, LT-2600 Vilnius, Lithuania
Phone/Fax: 370-2651602



Slovakia

SMC Priemyselná Automatizácia, s.r.o.
Námestie Martina Benku 10
SK-81107 Bratislava
Phone: +421 2 444 56725, Fax: +421 2 444 56028
E-mail: office@smc.sk
http://www.smc.sk



OTHER SUBSIDIARIES WORLDWIDE:

ARGENTINA, AUSTRALIA, BOLIVIA, BRASIL, CANADA, CHILE, CHINA, HONG KONG, INDIA, MALAYSIA, MEXICO, NEW ZEALAND, PHILIPPINES, SINGAPORE, SOUTH KOREA, TAIWAN, THAILAND, USA, VENEZUELA

<http://www.smceu.com>
<http://www.smcworld.com>